



PERFORMANCE OF HIGH-STRENGTH CONCRETE COLUMNS CONFINED BY MEDIUM STRENGTH OF SPIRALS AND HOOPS

Antonius*

Department of Civil Engineering, Sultan Agung Islamic University,
Jl. Raya Kaligawe Km.4, Semarang 50112, Indonesia

Received: 28 January 2013; **Accepted:** 5 June 2013

ABSTRACT

This paper presents on an experimental study of confined high-strength concrete columns tested under axial compression. The main objective of the research is to know the performance of spirals and hoops with medium strength ($400 \text{ MPa} < f_y < 600 \text{ MPa}$) in their contribution on the behaviour of confined high-strength concrete columns. The parameters of the study were concrete strengths, confining steel characteristics i.e: type of confinement (spirals and hoops), yield strength, spacing and volumetric ratio. From the experimental results it was found that the strength enhancement and ductility of confined concrete will decrease with if both of concrete strength and spacing of spirals or hoops increase, and the strain in the test also showed that the release of a cover of concrete core occurs prematurely. Other results shows that satisfactory of circular hoops as confinement steel behaved as good as the spiral reinforcement. The spiral reinforcement provision adopted in the Indonesian Concrete Standard 2002 (SNI 03-2847-2002) is quite reliable when applied in the design of confining steel with medium strength of high-strength concrete columns, therefore it is proposed that the upper limit provision of yield strength of confining steel warrant to be modified.

Keywords: High-strength concrete; confinement; strength; ductility; spiral and hoop.

1. INTRODUCTION

1.1 Background

Today the development of concrete technology has improved by leaps and bounds, especially the production of concrete materials which has superior properties such as fracture toughness, high durability etc., so in some countries the production of concrete that has a higher

* E-mail address of the corresponding author: antoni67a@yahoo.com (Antonius)

compressive strength of 50 MPa has become commonplace [1-3]. Similarly in Indonesia, high-strength concrete (HSC) research has been growing and intensively over the last decade [4-6].

As we know that the brittle nature owned by the causes the concrete core restraint behaviour, especially on the structure of the column, a problem that is very essential, especially for structures that are strong earthquake zone. The installation of reinforcement ratio adequate restraint is very important to do, especially on the structure of the columns. Some examples of structural failures caused by earthquake in Indonesia were in Aceh earthquake (2004), Yogyakarta earthquake (2006) and the Padang earthquake (2009) it has provided many lessons to us, one of the factors was the absence of confining reinforcement installation with sufficient quantity and quality, especially in the beam-column structural components and regional potential occurrence of plastic hinge [7-8].

1.2 Code Problem

Study of the literature shows that in normal-strength concrete (NSC) columns, the installed of circular spiral reinforcement has the best quality properties than other types of reinforcement restraints in absorbing seismic energy [9]. Due to their shape, circular spirals, are in axial hoop tension and provide a continuous confining pressure around the circumference. However, square or rectangular hoops can only be applied for the confining reactions near the corners of the hoops since the sides of the hoops tend to bend outwards due to internal concrete pressure.

The minimum total volumetric ratio of circular spirals or hoops adopted in Indonesian National Standard 2002 (SNI 03-2847-2002 or SNI) [10], and ACI-318-11 [11] is

$$\rho_s = 0.45 \left(\frac{A_g}{A_c} - 1 \right) \frac{f'_c}{f_y} \quad (1)$$

The equation used by SNI limits the spiral yielding stress placed not more than 400 MPa, at which the limit of maximum yield stress is different from the standard of ACI-318-11 allows the use of spiral to about 10000 psi (~ 688 MPa). Referring to equation (1) above, one of the consequences in the design of spiral on columns made of too high-strength concrete is the requirement of higher volumetric ratio of spiral what makes the auto space required to be more tightly. The in the field the application is not practical, because it can lead to cleaner spiral spacing is smaller than the maximum aggregate size and in turn aggregate is also not able to enter. In anticipating this case, some researchers have proposed the use of a high-strength steel (f_y from 400 to 1300 MPa) so that installation is more practical in the field [5,12].

In spite of this, the use of too high-strength of steels also has constraints, such as the limited supplies on the market so it took an advance reservation compared with the normal strength steel ($f_y \leq 400$ MPa), in which it is very easy to obtain. Another constraint on the high-strength steel is brittle because it is relatively difficult in the process of forming a spiral or types of circular sections. Therefore, another alternative is to use a confining steel with moderate strength, i.e above the SNI provision but not too classy or too brittle to easily formed into a spiral or hoop. In this paper, rebars having yield strength 400 to 600 MPa are defined as medium strength. Research that uses confined by medium and high-strength spiral and hoop on the structure of the column them by Sheikh & Toklucu [13], but applied to normal-strength concrete columns. Other research conducted by Sharma et al. [2] and Pessiki & Pieroni [14], the study of high-strength concrete columns and all use confining type spiral reinforcement medium strength.

1.3 Objective

In this study conducted a study on the performance of columns confined by spirals and hoops with medium strength. The main objective of this research is to investigate the behaviour of confined high-strength concrete columns that include strength, ductility, cover spalling behaviour, as well as the effects of some parameters design of confining reinforcement. In addition to this, the results of this study will also be served as input to SNI 03-2847-2002 [10] in terms of provision within confining reinforcement design. Experimental method is done by making the specimen reinforced concrete columns with reviewing the design parameters such as the concrete strength, the characteristics of confining reinforcement such as volumetric ratio, spacing and yield strength.

2. EXPERIMENTAL PROGRAM

2.1 Materials and Ranges of Concrete Strengths

Three different mixes were used to set cylindrical strength target of HSC. A maximum aggregate size used was 14 mm. Deformed reinforcement with diameter of 9.3 mm and yield strength of 325 MPa were used as longitudinal reinforcement. For spirals and hoops were used plain rebars with diameter of 5.5 mm and 6.25 mm and yield strength varied from 315 through 587 MPa.

2.2 Instrumentation and Test Setup

Fourteen specimens of small scale columns with diameter of 110 mm and the height of each specimen was five times as big as its diameter. Specimens also include three unconfined concrete columns that serve as control specimens for compressive strength of concrete specimens with the same strength. Concrete cover was provided in all the specimens. It is respectively provided a clear cover thickness of 10 mm. LVDT (Linear Variable Differential Transducers) with 100 mm maximum stroke was used to measure the axial displacement of the specimen throughout the test. To measure the strain of reinforcement, four strain gages were attached to the longitudinal and confining steel within the central third of the specimen. Instrumentation of specimen can be seen in Figure 2. For the test purpose, the total height of each column was divided into 3 regions, comprising of two 175 mm regions at each end of the column, and 200 mm region in the middle as test region.

Table 1 gives the detail of the specimens. All columns were tested under concentric compression by Dartec Universal Testing Machine (UTM) with 1000 kN capacity. The tests were done under displacement control. Figure 1 shows the results of tensile testing of steel spiral and hoop that used on the specimen.

Table 1: Specimen details

Specimen	f'_c (MPa)	Lateral steel				Longitudinal steel			
		Shape	f_y (MPa)	ϕ -spacing (mm)	ρ_s (%)	$\frac{\rho_s}{\rho_{SNI}}$	f_{yt} (MPa)	Reinf. (mm)	ρ (%)
CC1	-	-	-	-	-	-	-	-	-
CS1	51.8	Spiral	488	6.25-35	4.38	1.27	325	5 ϕ 9.3	3.6
CH1	-	Hoop	488	6.25-35	4.38	1.27	-	-	-

CC2	-	-	-	-	-	-	-	-	
CS2	63.2	Spiral	488	6.25-35	4.38	1.04	325	5φ9.3	3.6
CS3			315	5.5-35	3.19	0.51			
CS4			315	5.5-55	2.03	0.32			
CC3			-	-	-	-			
CS5	75.3	Spiral	488	6.25-35	4.38	0.87	325	5φ9.3	3.6
CS6			587	6.25-35	4.38	1.05			
CS7			587	6.25-55	2.79	0.67			
CH2		Hoop	488	6.25-35	4.38	0.87			
CH3			567	6.25-35	4.38	1.01			
CH4	567	6.25-55	2.78	0.64					

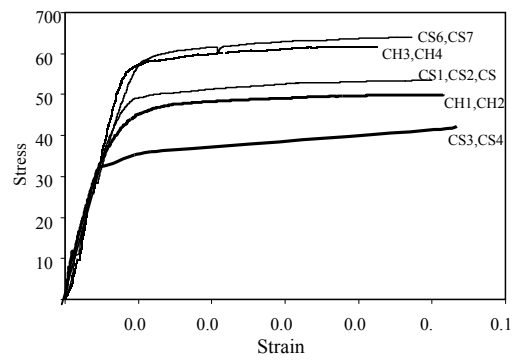

Figure 1. Stress-strain curves of spirals and hoops

2.3 Data Acquisition

Lateral stress f_2 can be found considering force equilibrium. Force equilibrium between the stress in the envelope and the confining stress applied to the concrete core results in:

$$f_2 = \frac{2.A_s.f_s}{s.d_c} \quad (2)$$

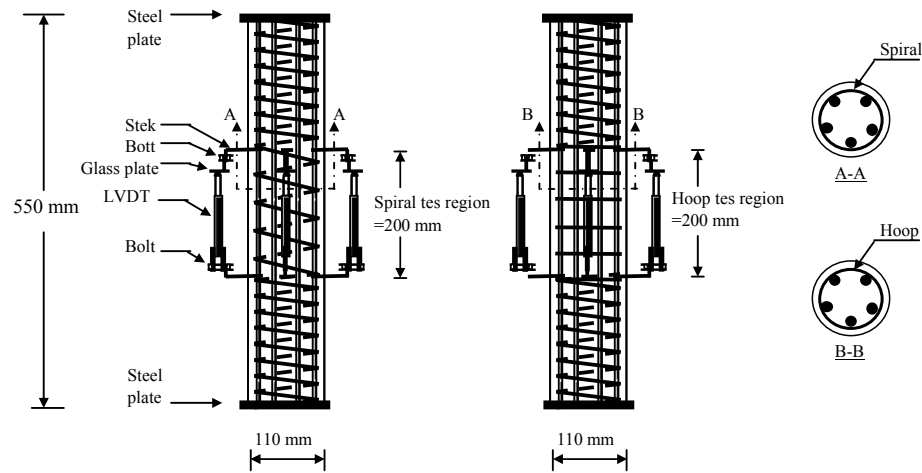

Figure 2. Instrumentation of specimen

Referring to the analysis of confined concrete columns test result conducted by Cusson & Paultre [15], the value of the column axial strain was obtained from the average price of 4 pieces LVDT divided by the height of tested area. The total load acting on the column (P_{exp}) can directly be read from the Data Loger. The loads sustained by concrete (P_c) on all columns were obtained from P_{exp} price reduced by the load received by the longitudinal reinforcement (P_s), (see Figure 3).

Data collection from spirals and hoops during the imposition is based on the data strain acquired from the strain gage. Supposed that value of spirals or hoops has reached the yielding point during the test, the determination of confining reinforcement stress (f_s) is based on the condition strain hardening from the steel tensile test in the Figure 1. Meanwhile, the determination of longitudinal reinforcement stress after yielding is based on the biliner condition on the steel tensile test result.

The stress of confined concrete (f_{cc}) is computed based on condition on two aspects, first is when the concrete cover is still working, and second is where the condition of the concrete core is working effectively or when the cover is removed [16]. The region of the confined concrete stress field is based on the conditions in the region 1 and 3, within the region 1 the cross-sectional area of concrete is equal to the column total cross-sectional area (including the concrete cover). The region 3, the calculated cross-sectional area is concrete core area. In the region 2, the concrete cover is still partially detached, what makes it impossible to determine the cross-sectional concrete sustaining the load. As a result, transition curve prediction is required to connect curve in the region 1 and 3 (see Figure 4).

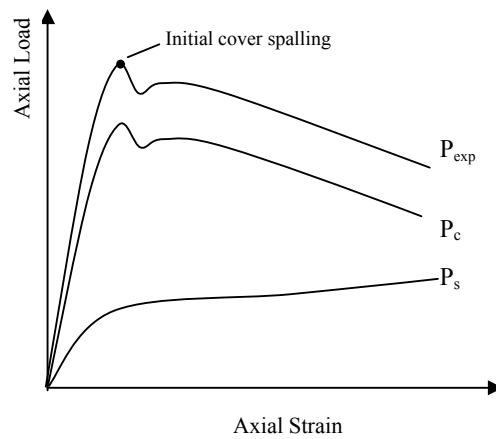

Figure 3. Definition of concrete contribution [15]

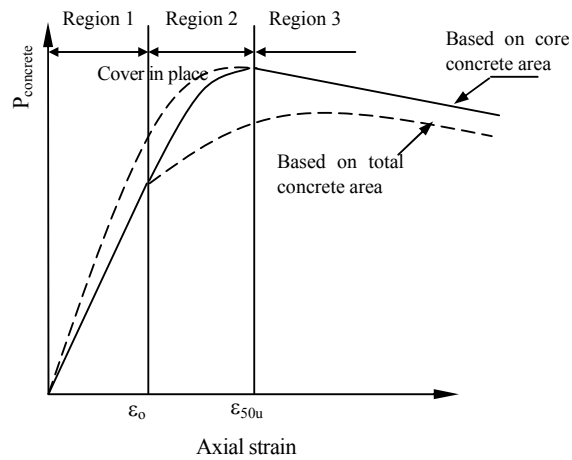

Figure 4. Calculation of confined concrete stress

The value of strength enhancement of confined concrete (K) is defined as a ratio between the confined concrete stress at maximum response (f'_{cc}) with 85% of cylindrical concrete stress of 150/300 mm. Ductility of confined concrete column (μ) in this study is defined as the ratio between the strain of confined concrete columns to the area after the peak response at 85% from the peak stress (ε_{85c}) to concrete columns strain of unconfined concrete corresponding to peak stress of confined concrete columns (ε_{0f}).

3. EXPERIMENTAL RESULTS AND DISCUSSION

The experimental results tabulated in Table 2. The specimens were tested until failure and their process were initiated with cracking in the cover. In most of the specimens, the spalling of concrete cover was observed to occur simultaneously with the occurrence of maximum response of the columns. Tests of plain concrete columns showed that in-place strength of concrete

(unconfined) in columns were 86%, 87% and 83% of strengths determined by standard cylinder tests (f'_c) for specimens with 51, 63 and 75 MPa. This implies that $0.85f'_c$ commonly used to express the in-place strength of normal-strength concrete.

As shown in Table 2, almost all of the specimens, spirals and hoops have not reached their yielding during the peak response. But for the specimens of CS3 and CS4 spiral have yielded. Spiral on specimen CS3 and CS4 has yield strength much lower than the provision of the SNI so that it can be mobilized optimally during peak response.

3.1 Column Axial Capacity

Axial capacity of the column test results ($P_{exp.}$) in Table 2 compared with column axial capacity theoretically (3).

$$P_o = 0,85 f'_c (A_g - A_s) + f_{yl} A_{st} \tag{3}$$

Comparison between the maximum column axial force on the column axial capacity theoretical ($P_{exp.}/P_o$) in Table 2 shows that in general such comparisons have value above 1. Only specimens CS3 and CS4 that have value $P_{exp.}/P_o$ is lower than 1. Figure 5 shows the relationship between the content of the normalized reinforcement bracing attached to the compressive strength of concrete ($\rho_s f_y/f'_c$) with $P_{exp.}/P_o$. The test results are also compared with the data of test results for high-strength concrete columns that have been done by other researchers. The figure shows that the value $P_{exp.}/P_o$ for high-strength concrete column is between 0.73 and 1.4. Value $P_{exp.}/P_o$ remained above 1 if the value $\rho_s f_y/f'_c$ is above the range of 30, which is shown by the results of testing by Saatcioglu & Razvi [1], Sharma et al. [2], Cusson & Paultre [15], Sun et al. [17], Nemecek et al. [18], and the results of this experiment. For value $P_{exp.}/P_o$ above 1 [19], indicates that the spiral and hoop are installed in high ratio also has a significant contribution in the column axial capacity in addition to the strength of concrete on the column itself is quite dominant and the contribution of longitudinal reinforcement.

Table 2: Experimental Results

Specimen	$P_{max.}$ (kN)	$P_c max.$ (kN)	At maximum response		f'_{cc} (MPa)	ϵ'_{cc}	ϵ'_{co}	ϵ_{01}	ϵ_{spall}	ϵ_{85c}	$K = \frac{f'_{cc}}{0.85 f'_c}$	$\mu = \frac{\epsilon_{85c}}{\epsilon_{01}}$
			ϵ_2	f_2 (MPa)								
CC1	423.35	423.35	-	-	44.55	0.0023					1	-
CS1	555.70	445.37	0.00185	437.81	80.99	0.006	0.0023	0.0055	0.0020	0.0281	1.77	5.1
CH1	559.93	449.60	0.0017	432.08	81.66	0.0058		0.0048	0.0022	0.0153	1.77	3.2
CC2	522.53	522.53	-	-	54.98	0.0026					1	-
CS2	621.67	539.31	0.00145	423.95	97.95	0.0052	0.0026	0.0065	0.0020	0.0281	1.67	4.3
CS3	512.47	402.14	0.00131	319.28	74.36	0.0048		0.0034	0.0025	0.0060	1.53	1.8
CS4	438.80	355.70	0.000936	320.71	65.77	0.0042		0.0026	0.0026	0.0047	1.32	1.8
CC3	593.95	593.95	-	-	62.50	0.0028					1	-
CS5	782.44	672.12	0.00228	399.10	122.07	0.0052		0.0061	0.0024	0.0154	1.62	2.5
CS6	780.89	670.56	0.0011	423	121.79	0.0057		0.0049	0.0020	0.0122	1.60	2.5
CS7	698.60	588.27	0.00285	510.74	106.84	0.0048	0.0028	0.0049	0.0030	0.0140	1.55	2.9
CH2	873.24	762.91	0.000654	394.32	138.56	0.0055		0.0056	0.0028	0.0184	1.54	3.3
CH3	878.68	768.35	0.00235	444.50	139.55	0.0051		0.0073	0.0023	0.0126	1.66	1.7
CH4	704.71	633.54	0.002364	518.25	115.06	0.0051		0.0053	0.0022	0.0096	1.60	1.8

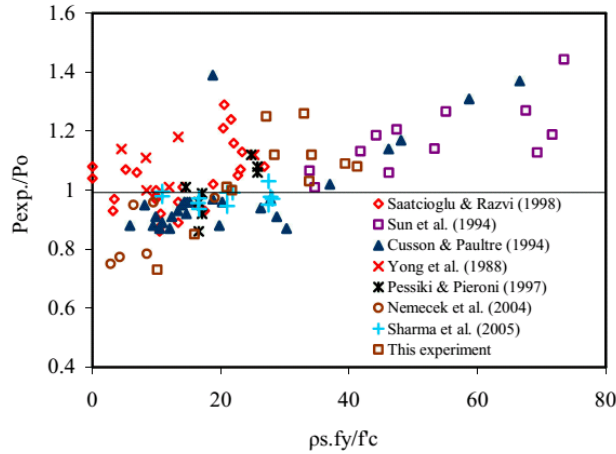

Figure 5. Relationship between $\rho_s f_y / f'_c$ vs P_{exp} / P_o

3.2 Behavior of cover spalling

The study of the literatures shows that on HSC columns, the process of cover spalling of concrete core occurs prematurely, in which the concrete strain at initial cover spalling is lower than concrete strain of unconfined concrete [20-22]. Tabel 2 shows that the strain during the initial concrete cover spalling (ϵ_{spall}) ranges from 0.002 to 0.0031. Furthermore, Figure 6 shows the relationship between the content posted lateral reinforcement were normalized to the concrete compressive strength ($\rho_s f_y / f'_c$), with the ratio between the strain at the beginning of the cover concrete spalling of the concrete strain of unconfined concrete ($\epsilon_{spall} / \epsilon'_{co}$). The figure shows that the majority of specimens, the value $\epsilon_{spall} / \epsilon'_{co}$ in general is below 1. This means that the current strain in concrete cover spalling occurs more rapidly than the strain of unconfined concrete. This result is also roughly equal to the results of tests performed by Cusson & Paultre [15].

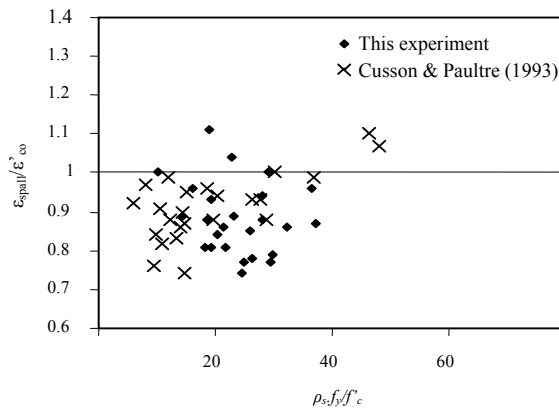

Figure 6. Relationship between $\rho_s f_y / f'_c$ vs $\epsilon_{spall} / \epsilon'_{co}$

3.3 Influence of concrete strength

Figure 7 shows comparisons of columns with different concrete strengths. The results indicate a consistent decrease in strength enhancement (K) and ductility with increasing concrete strengths. This behaviour can also be seen in the values of K and μ in Table 2.

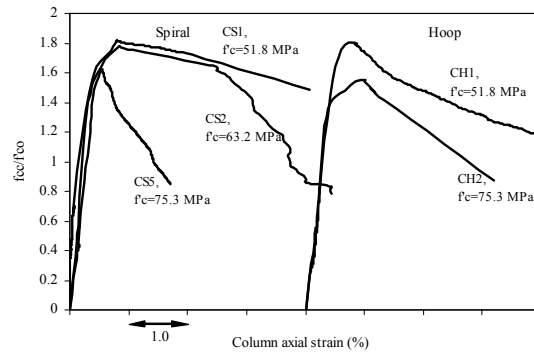

Figure 7. Influence of concrete strength

3.4 Influence of spacing and volumetric ratio

Behaviour of confined concrete with different tie spacing is shown in Figure 8. These columns have different volumetric ratio of confining steel. The effectiveness of confining steel diminishes quickly with increasing tie spacing. Specimens with wide tie spacing may not develop any confinement.

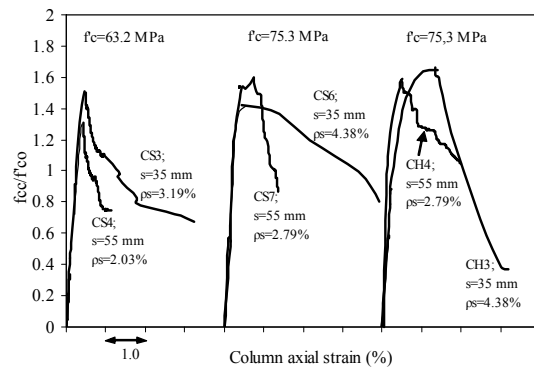

Figure 8. Influence of spacing and volumetric ratio

3.5 Influence of yield strength

Effect of yield strength installed in the specimens that have performed concrete compressive strength, and the ratio of the same space but yield strength of spiral or hoop is used differently. Specimens compared are CS5 vs CS6 and CH2 vs CH3. Based on the behaviour observed in Figure 9, comparison between specimens CS5 and CS6 shows that an increase of yield strength of spirals in results that there are no different in K value and ductility of confined concrete significantly. However, for comparison specimens installed hoop, K value and ductility changes although not too significant.

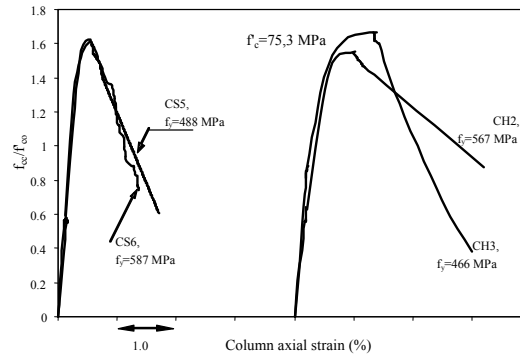

Figure 9. Influence of yield strength of spirals and hoops

3.6 Performance between spiral and hoop

Figure 10 shows the satisfactory performance of circular hoops as confinement reinforcement, especially for comparisons of CH1 vs CS1 and CH2 vs CS5. Another comparison shows that specimen CH3 has K value higher although in lower ductility than specimen CS6. The hoops behaved as well as the spiral reinforcement. Spiral and hoop stresses at maximum concrete stress were reasonably close in almost all the comparable specimens. In that figure, the behaviour of hoped concrete was somewhat superior to that of spirally reinforced concrete in the strength enhancement of confined concrete. Similar with the suggestion by Sheikh & Toklucu [13], the use of hoops might be preferable due to the fact that each hoop behaves independently and rupture of one single hoop would not affect the confinement provided by the remaining hoops, although other hoops may also be close to rupture. On the other hand, rupture of spiral steel at one location would cause relaxation of lateral confining stress on the concrete core wherever cover concrete has been spalled off.

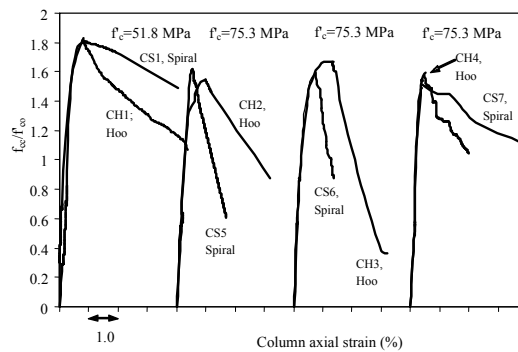

Figure 10. Performance between spirals and hoops

4. SNI CODE REQUIREMENT VALIDATION

Terms installation spiral reinforcement by SNI equation (1) in advance is basically derived by

overriding philosophy that spiral can provide lateral stress applications effectively to the concrete core columns after the concrete covers off. Equation (1) is developed from the equation increase strength confined concrete proposed by Richart et al. [23], namely:

$$K = \frac{f'_{cc}}{f'_c} + 4.1 \frac{f_2}{f'_c} \tag{4}$$

For the record, f'_c notation above equation is proportional to the stress of unconfined concrete. Value of 4.1 in the equation is the effectiveness of confinement (k) the average of the results of normal strength concrete based on triaxial testing conducted by Richart et al. Furthermore, experimental results on a study of data are processed to obtain the value of the effectiveness of confinement (k) each specimen, obtained from equation (5). The stress of unconfined concrete is defined by 85% of f'_c , and lateral stress f_2 calculated by equation (2).

$$k = \frac{f'_{cc} - 0.85f'_c}{f_2} \tag{5}$$

Figure 11 shows the results of the calculation of the effectiveness of confinement each specimen were also compared with the values espoused restrained effectiveness in SNI and ACI. Based on the figure, the value of k specimens CS1, CH1, CS6, CH2 and CH3 is below k by SNI, but on another specimen k value is higher than the assumed value of k by SNI.

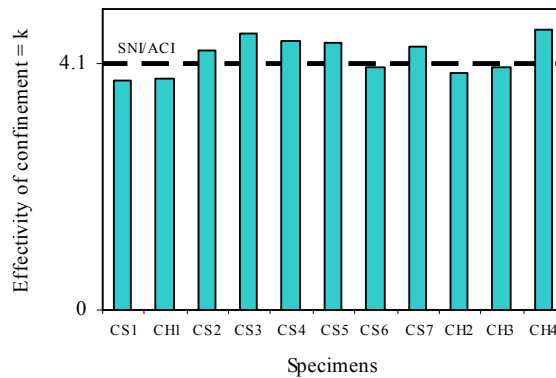

Figure 11. Effectivity of confinement for specimens

Further linear regression to determine the value of k in general the experimental results of the data shown in Figure 12, which results in the equation:

$$K = \frac{f'_{cc}}{f'_c} + 4.136 \frac{f_2}{f'_c} \tag{6}$$

Value of confinement effectiveness in equation (6) is ($k=4.136$ or $k\sim 4.1$) essentially the same as the the value of k in equation (4). Thus it can be said that the provision of installation of spiral or hoop reinforcement by SNI still quite reliable and realistic when used in high-strength concrete columns are confined by the medium strength of spirals and hoops conducted in this

study.

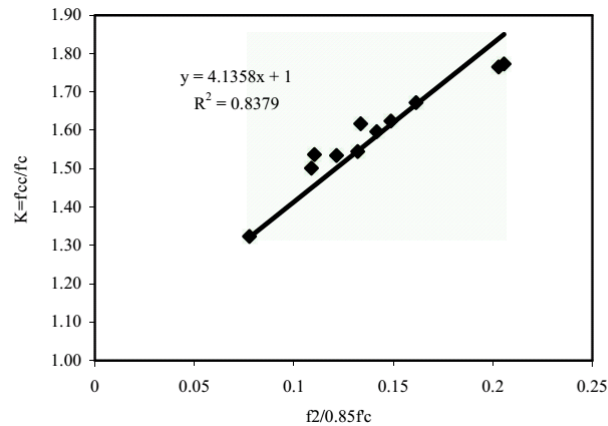

Figure 12. Regression of K equation

5. CONCLUSION

In this paper has elaborated on the research of HSC columns confined by spirals and hoops with medium strength. In general, the installation of medium strength spirals and hoops with a higher ratio of a significant role in increasing the strength and ductility of confined concrete and column axial capacity. The events cover spalling prematurely, which confined concrete strain at the initial of cover spalling occurs more rapidly than concrete strain of unconfined concrete. Strength and ductility of reinforced concrete columns is dependent on the confinement provided by the confining (i.e. concrete compressive strength, volumetric ratio). Strength enhancement of confined concrete tends less of strength and ductility with increasing the concrete strength. The larger of volumetric ratio of confining steel, the more ductile is the behaviour of confined concrete columns. The effect of increasing of yield strength of confining steel performed in this study does not have significant effect on the strength and ductility of HSC columns. Hoops, in this case, perform as good as confinement and the spiral reinforcement. Requirements by SNI for spiral reinforcement in equation (1) is still quite reliable and feasible to be applied in the design of spiral or hoop with medium strength ($400 \text{ MPa} < f_y < 600 \text{ MPa}$) on the HSC columns. Therefore, it is proposed that the upper limit of yield strength of confining steel in the SNI code warrant to be modified become medium strength quality.

Acknowledgments: The experimental program presented in this paper funded by Directorate General of Higher Education, Ministry of National Education, Republic of Indonesia through the Competitive Research Program (Hibah Bersaing). The support received for this research successfully is gratefully acknowledged.

REFERENCES

1. Saatcioglu M, Razvi SR. High strength concrete columns with square sections under

- concentric compression, *ASCE Journal of Structural Engineering*, **124**(1998), 1438-47.
2. Sharma UK, Bhargava P, Kaushik SK. Behavior of confined high strength concrete columns under axial compression, *Journal of Advanced Concrete Technology*, **3**(2005), 267-81.
 3. Nishiyama M. Mechanical properties of concrete and reinforcement—state-of-the-art report on and HSS in Japan, *Journal of Advanced Concrete Technology*, **7**(2009), 157-82.
 4. Imran I, Moestopo M, Suharwanto. Strength and deformation of confined high strength concrete, *1st International Conference on Advances in Structure Engineering and Mechanics*, Seoul, Korea, August 23-25 (1999), pp. 373-378.
 5. Djauhari Z, Imran I, Setio HD. Behaviour of strength and ductility of high-strength concrete confined by high-strength steel, *Proceeding of HAKI Conference and Exhibition 2007*, Earthquake Resistant Construction in Indonesia (in Indonesian).
 6. Antonius and Imran I. Experimental study of confined low, medium and high-strength concrete subjected to concentric compression, *ITB Journal of Engineering Science*, **44**(2012) 252-69.
 7. Imran I, Suarjana M, Hoedajanto D, Soemardi B, Abduh M. Lessons from Yogyakarta Earthquake: Performance Study of Buildings, *HAKI Journal*, **7**(2006) 1-13 (in Indonesian).
 8. Meas K, Li B, Imran I. Seismic performance of lightly reinforced concrete exterior beam-column joints, *Advances in Structural Engineering*, **15**(2012) 1765-79.
 9. Wight JK, MacGregor JG. *Reinforced Concrete, Mechanics and Design*, Fifth Edition, Pearson Education International, 2009, Chapter 11.
 10. Indonesian National Standard, *Methods of Calculation of Reinforced Concrete for Building*, SNI-03-2847-2002, 2002 (in Indonesian).
 11. ACI Committee 318. *Building Code Requirements for Structural Concrete (ACI-318-11) and Commentary (318R-11)*, American Concrete Institute, Farmington Hills, MI, 2011.
 12. Bayrak O, Sheikh SA. Seismic performance of high strength concrete columns confined with high strength steel, *13th World Conference on Earthquake Engineering*, Vancouver, Canada, August 1-6, 2004, Paper No.1181.
 13. Sheikh SA, Toklucu MT. Reinforced concrete columns confined by circular spirals and hoops, *ACI Structural Journal*, **90**(1993) 542-53.
 14. Pessiki S, Pieroni A. Axial load behavior of large-scale spirally-reinforced columns, *ACI Structural Journal*, **94**(1997) 304-14.
 15. Cusson D, Paultre P. Experimental study of high-strength concrete columns confined by rectangular ties, *Utilization of High-Strength Concrete in Europe, Proceedings in Lillehammer*, Norway, June 20-23 (1993), pp. 136-145.
 16. Antonius, Imran I, Suhud R, Munaf DR. Response of high-strength concrete columns under concentric loadings, *Proceeding of National Conference of Earthquake Engineering*, ITB Bandung, 4-5 November 1999, IV19-IV29 (in Indonesian).
 17. Sun YP, Sakino K, Watanabe K, Tian FS. Effect of configuration of transverse hoops on the stress-strain behavior of concrete, *Transactions of the Japan Concrete Institute*, **16**(1994) 49-56.
 18. Nemecek J, Padevet P, Bittnar Z. Effect of stirrups on behavior of normal and high strength concrete columns, *Acta Polytechnica Czech*, **44**(2004) 158-64.
 19. Yong YK, Nour MG, Nawy EG. Behaviour of laterally confined high strength concrete

- under axial loads, *ASCE Journal of Structural Engineering*, **114**(1988) 332-51.
20. Foster SJ, Liu J, Sheikh SA. Cover spalling in columns loaded in concentric compression, *ASCE Journal of Structural Engineering*, **124**(1998) 1431-7.
 21. Bae S, Bayrak O. Early cover spalling in high-strength concrete columns, *ASCE Journal of Structural Engineering*, **129**(2003) 314-23.
 22. Antonius. The influence of lateral reinforcement to the mechanism of cover spalling of high-strength concrete column, *Proceeding of National Conference of Earthquake Engineering II*, Yogyakarta Indonesia, January, 2004, 68-76 (in Indonesian).
 23. Richart FE, Brandtzaeg A, Brown RL. A Study of the failure of concrete under combined compressive stresses, University of Illinois, *Engineering Experiment Station*, **26**(1928).

NOTATIONS

- A_g = gross concrete area of cross section in column
 A_s = area of cross section of longitudinal reinforcement
 \emptyset = diameter of reinforcement (spiral and hoop)
 d_c = concrete core diameter
 f_2 = lateral stress of confining steel
 f'_c = compressive strength of standard cylinder test at 28 days
 f_{cc} = stress of confined concrete
 f'_{cc} = peak strength of confined concrete
 f'_{co} = peak strength of unconfined concrete
 f_s = actual strength of confining steel (spiral or hoop)
 f_y = yield strength of confining steel (spiral or hoop)
 f_{yl} = yield strength of longitudinal reinforcement
 ϵ'_{co} = peak strain of unconfined concrete
 ϵ'_{cc} = peak strain of confined concrete
 ϵ_{spall} = initial strain of cover spalling
 ϵ_{0l} = concrete columns strain of unconfined concrete corresponding to peak stress of confined concrete columns
 ϵ_{85c} = strain corresponding to the 85% peak stress of confined concrete
 K = strength enhancement of confined concrete
 $= f'_{cc}/0.85f'_c$
 k = confinement effectiveness
 P_c = axial loads sustained by concrete
 P_{max} = maximum compressive load resisted by column
 P_o = axial capacity of column
 $= 0.85f'_c (A_g - A_s) + f_{yl} A_s$
 P_s = axial loads received by longitudinal reinforcement
 μ = ductility ratio of confined concrete
 ρ_s = volumetric ratio of spiral or hoop steel
 s = spacing of confining steel measured centre-to-centre of the steel